



Secure Stack[®]

Modular Double-Wall Positive Pressure Chimney Boiler
Breeching and Stack, Engine Exhaust, and Grease Duct



www.securitychimneys.com
800-361-4909 (US) 800-667-3387 (Canada)

Secure Stack® CIX/CAX

The Secure Stack CIX and CAX venting systems are designed to offer the ultimate in installation convenience and versatility for a variety of applications. Certified for commercial chimney, grease duct (CIX only) and diesel exhaust applications. Thick-gauge material for the inner pipe and coupling provides a strong and rigid assembly. Self-centering flue design significantly simplifies and accelerates the installation process. Coupling configuration (patent pending) requires only one locking band and the use of a regular, less expensive, high-temperature silicone sealant.

A TRADITION OF EXCELLENCE

For over 50 years, Security Chimneys has been an innovator in the venting field and a market leader in North America. Instrumental in the company's growth has been an ongoing focus on product improvement and the introduction of new, innovative products. The CIX and CAX venting systems are prime examples of our constant quest for more cost-effective, versatile and reliable product solutions.

DESIGNED WITH PERFORMANCE IN MIND

Available in sizes from 5- to 36-inch diameters, the CIX line offers double-wall, 2-inch insulated chimneys, and the CAX offers a 2-inch air insulated product. For premium corrosion resistance and durability, the inner flue is constructed from 0.035-inch-thick Stainless Steel 304 or 316. This is coupled with a 0.018-inch-thick Stainless Steel 304, 316 or Galvalume (Aluminum-zinc coated) steel outer casing. The CIX is lined with the highest-quality insulation, densely packed to ensure low heat loss, maximum draft and a 1-inch clearance to combustible materials.

SIGNIFICANT COST AND TIME SAVINGS

The couplings are completely welded to the inner flue pipe for reinforced strength and to help prevent leakage. These male and female couplings then extend the inner pipe up to the outside and allow sealing of the inner flue at the exterior of the pipe. This greatly reduces the temperature at the locking/sealing location so a more conventional and less expensive high-temperature silicone can be used. Plus, only one locking band is necessary as opposed to the two required for competitive products.

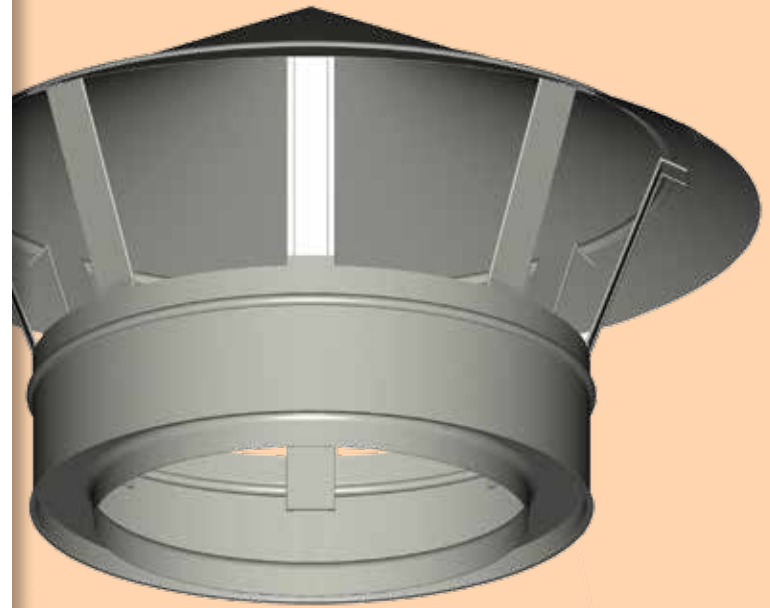

SECURITY CHIMNEYS SECURE STACK

A POSITIVE PRESSURE SYSTEM



Features	Benefits
Self-centering	<ul style="list-style-type: none">• Components line up easily and quickly• Fast and efficient installations
Joint sealing on outside casing only (patent pending)	<ul style="list-style-type: none">• Lower temperature at locking/sealing location• Less expensive high-temperature silicone sealant can be used• Awkward inner band eliminated• Easier to install
Thinner-gauge material on outside casing	<ul style="list-style-type: none">• Lower weight• Easier to install

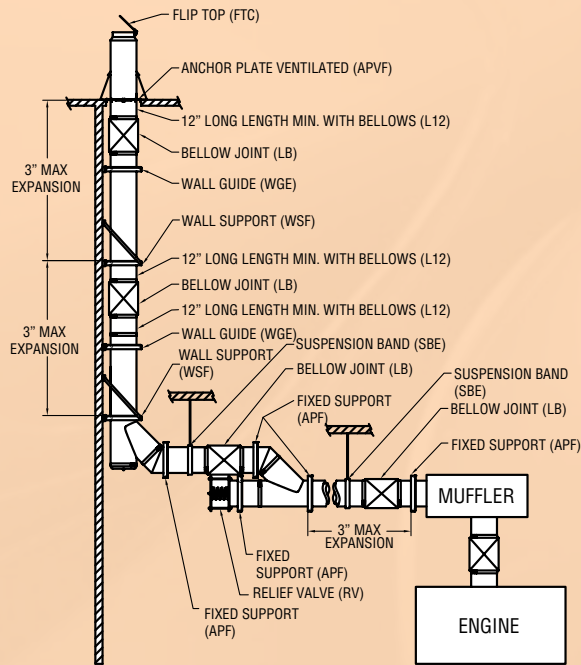

Coding Logic:

This document contains a description of each of the parts for the CIX/CAX Secure Stack systems, as well as their respective application.

The following examples of our coding system should make it easier for you to identify or order them.

Material code definitions:

- B = Stainless 316
- C = Stainless 304
- E = Alu-Zinc coating (Galvalume)

CODING LOGIC EXAMPLE

CIX14L36BC		CAX22E30CE		CIX8WSF	
CIX	Model	CAX	Model	CIX	Model
14"	Inside Diameter	22"	Inside Diameter	8"	Diameter
L36	36" Length	E30	30° Elbow	WS	Wall Support
BC	Inner/Outer Material	CE	Inner/Outer Material	F	Inner/Outer Material

MATERIAL THICKNESS/JOINT

Diameters	Material		Thickness		Joint	
	Exterior	Interior	Exterior	Interior	Exterior	Interior
5" - 12"	304 / 316 galvalume	304 / 316	0,018"	0,035"	LASER WELD	LASER WELD
14" - 24"	304 / 316 galvalume	304 / 316	0,018"	0,035"	PITTSBURG LOCK	PLASMA WELD
26" - 36"	304 / 316 galvalume	304 / 316	0,024"	0,035"	PITTSBURG LOCK	PLASMA WELD

OPERATING TEMPERATURES AND CLEARANCES

Criteria	Restaurant Grease Duct (CIX Only)	Building Heating Appliance Chimney	1400°F Factory-Built Chimney
Application	Cooking Appliances; Ventilation Hoods; Restaurant Grease Ducts; Pizza Oven Exhaust	Low- and High-Pressure Steam Boilers; Building Heating Equipment	Industrial Furnaces; Processing Equipment; Kilns and Ovens; Diesel and Turbine Exhaust
Maximum Operating Temperatures	500°F Continuous 2000°F Intermittent	1000°F Continuous 1400°F Intermittent	1400°F Continuous 1800°F Intermittent
CIX Clearances To Combustibles Ø5" to Ø36"	2"	1"	1"
CAX Clearances To Combustibles Ø5" to Ø36"	N/A	4"	4"

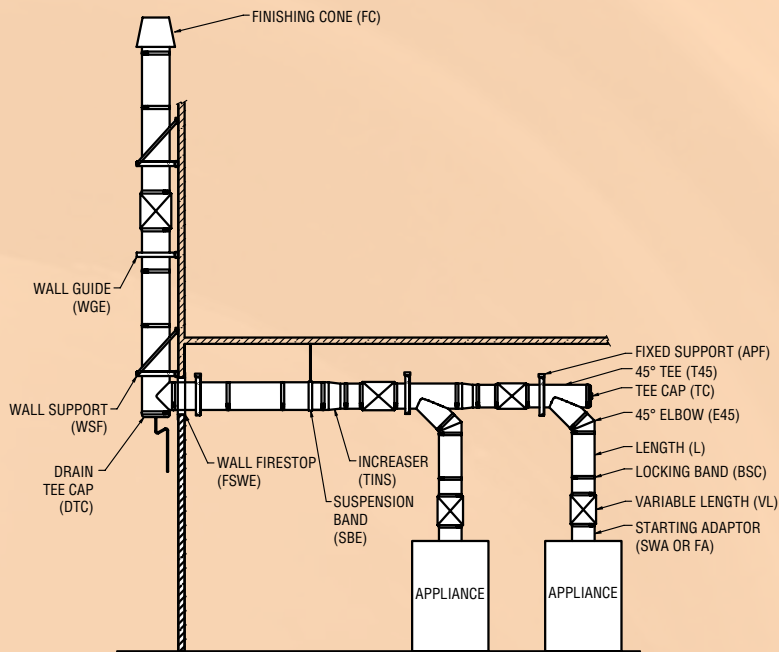

Installation

Pipe and fitting joint assembly

All components have a male and a female end. The installation orientation is indicated on the labeling of each pipe section with an arrow. The arrow indicates the direction of the flue. Clean all inner and outer surfaces of the male and female ends with an appropriate organic solvent, such as acetone, Mek, or other commercial degreaser.

1. Apply high-temperature sealant to male end of pipe. See installation instructions for sealant choice and location.
2. Insert the female end of the pipe into the male end of another section of pipe with sealant (see Figure 1).
3. Position the assembly band around the joint of the two sections. Sealant may be required. See installation instructions.
4. Screw together the two ends of the band (see Figure 2).



Figure 1



Figure 2

Lengths

Lengths

Available in sizes from 5- to 36-inch diameters, the CIX line offers double-wall, 2-inch insulated chimneys, and the CAX offers a 2-inch air insulated product.

Ø	Length	Effective Length	CIX	CAX
5" to 36"	12"	11 3/8"	CIXØL12	CAXØL12
5" to 36"	18"	17 3/8"	CIXØL18	CAXØL18
5" to 36"	24"	23 3/8"	CIXØL24	CAXØL24
5" to 36"	36"	35 3/8"	CIXØL36	CAXØL36

Locking band included. Materials available: 304, 316, Galvalume.
Flow resistance: $K = 0.4$ (eff. length [ft] / Ø [in]); $K = 0.25$ (eff. length [ft] / Ø [in]); For engine or turbine exhaust.

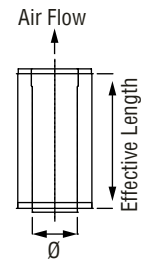

Adjustable Lengths

Used to add length. Adjust to fit odd dimensions and compensate for thermal expansion. Suitable for application on a low positive pressure system with less than 1" water column. Locking band included.

Ø	Effective Length	CIX	CAX
5" to 36"	8" to 24"	CIXØLA	CAXØLA

Graphite packing included. Materials available: 304, 316, Galvalume.
Flow resistance: $K = 0.4$ (eff. length [ft] / Ø [in]); $K = 0.25$ (eff. length [ft] / Ø [in]); For engine or turbine exhaust.

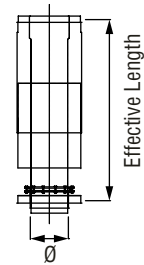

Variable Lengths

Used to adjust to fit odd dimensions. Not used for thermal expansion. Can be used in positive pressure applications. Locking band included.

Ø	Effective Length	CIX	CAX
5" to 36"	4" to 26"	CIXØLV	CAXØLV

For engine or turbine exhaust. Materials available: 304, 316, Galvalume.
Flow resistance: $K = 0.4$ (eff. length [ft] / Ø [in]); $K = 0.25$ (eff. length [ft] / Ø [in]); For engine or turbine exhaust.

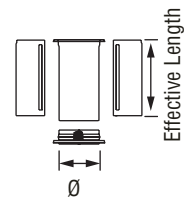

Bellows Lengths

Use to compensate for thermal expansion and to minimize vibration. For diameters larger than 24" the part will require special ordering and additional lead time will apply. Has a 3" maximum compression. Locking band and liner included.

Ø	Effective Length	CIX	CAX
5" to 36"	17-3/8"	CIXØLB	CAXØLB

Materials available: 304, 316, Galvalume.
Flow resistance: $K = 0.4$ (eff. length [ft] / Ø [in]); $K = 0.25$ (eff. length [ft] / Ø [in]); For engine or turbine exhaust.

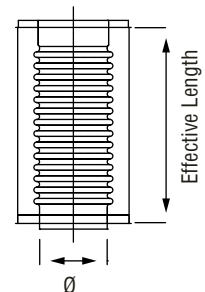

Drain Lengths

Use to drain rainwater or condensation from inner wall. Locking band included.

Ø	Effective Length	CIX	CAX
5" to 36"	17-3/8"	CIXØDL	CAXØDL

Materials available: 304, 316, Galvalume.
Flow resistance: $K = 0.25$

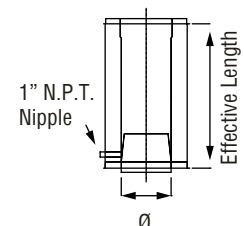

Lengths

Horizontal Drain Lengths

Use as a horizontal drain in grease duct applications. Locking band included.

Ø	Effective Length	CIX	CAX
5" to 36"	17-3/8"	CIXØHDL	CAXØHDL

Materials available: 304, 316, Galvalume.
Flow resistance: $K = 0.4$ (eff. length [ft] / Ø [in])

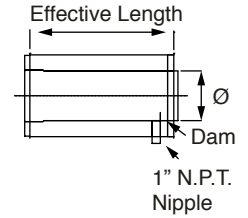

Nozzle Lengths

Use to insert a fire-suppression or wash-down nozzle in CIX grease duct applications. Use as a test port in CAX applications. Locking band included.

Ø	Effective Length	CIX	CAX
5" to 36"	17-3/8"	CIXØNL	CAXØNL

Materials available: 304, 316, Galvalume.
Flow resistance: $K = 0.4$ (eff. length [ft] / Ø [in])

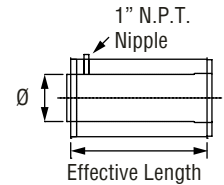

Elbows

3° Elbow Kits

Use to change direction of the stack or to provide offset. 3° elbows provide a minimum slope for horizontal run. Locking band included. Comes in pairs. Effective Length 17 3/8".

Ø	Angle	Offset	Height	CIX	CAX
5"	3°	N/A	3-19/32"	CIX5EK3	CAX5EK3
6"	3°	N/A	3-5/8"	CIX6EK3	CAX6EK3
8"	3°	N/A	3-11/16"	CIX8EK3	CAX8EK3
10"	3°	N/A	3-3/4"	CIX10EK3	CAX10EK3
12"	3°	N/A	3-25/32"	CIX12EK3	CAX12EK3
14"	3°	N/A	3-27/32"	CIX14EK3	CAX14EK3
16"	3°	N/A	3-29/32"	CIX16EK3	CAX16EK3
18"	3°	N/A	3-15/16"	CIX18EK3	CAX18EK3
20"	3°	N/A	4"	CIX20EK3	CAX20EK3
22"	3°	N/A	4-1/16"	CIX22EK3	CAX22EK3
24"	3°	N/A	4-3/32"	CIX24EK3	CAX24EK3
26"	3°	N/A	4-5/32"	CIX26EK3	CAX26EK3
28"	3°	N/A	4-7/32"	CIX28EK3	CAX28EK3
30"	3°	N/A	4-1/4"	CIX30EK3	CAX30EK3
32"	3°	N/A	4-5/16"	CIX32EK3	CAX32EK3

Flow resistance: $K = 0.03$



Elbows

15° Elbows

Use to change direction of the stack or to provide offset.

Ø	Angle	Offset	Height	CIX	CAX
5"	15°	11/16"	5-7/16"	CIX5E15	CAX5E15
6"	15°	3/4"	5-9/16"	CIX6E15	CAX6E15
8"	15°	3/4"	5-7/8"	CIX8E15	CAX8E15
10"	15°	13/16"	6-1/8"	CIX10E15	CAX10E15
12"	15°	13/16"	6-3/8"	CIX12E15	CAX12E15
14"	15°	7/8"	6-5/8"	CIX14E15	CAX14E15
16"	15°	7/8"	6-7/8"	CIX16E15	CAX16E15
18"	15°	15/16"	7-1/8"	CIX18E15	CAX18E15
20"	15°	15/16"	7-3/8"	CIX20E15	CAX20E15
22"	15°	1"	7-11/16"	CIX22E15	CAX22E15
24"	15°	1"	7-15/16"	CIX24E15	CAX24E15
26"	15°	1-1/16"	8-3/16"	CIX26E15	CAX26E15
28"	15°	1-1/8"	8-7/16"	CIX28E15	CAX28E15
30"	15°	1-1/8"	8-11/16"	CIX30E15	CAX30E15
32"	15°	1-3/16"	8-15/16"	CIX32E15	CAX32E15
34"	15°	1-3/16"	9-3/16"	CIX34E15	CAX34E15
36"	15°	1-1/4"	9-1/2"	CIX36E15	CAX36E15

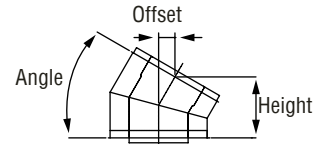

45° Elbows

Use to change direction of the stack or to provide offset.

Ø	Angle	Offset	Height	CIX	CAX
5"	45°	2-13/16"	6-15/16"	CIX5E45	CAX5E45
6"	45°	2-15/16"	7-1/4"	CIX6E45	CAX6E45
8"	45°	3-1/4"	8"	CIX8E45	CAX8E45
10"	45°	3-9/16"	8-11/16"	CIX10E45	CAX10E45
12"	45°	3-13/16"	9-3/8"	CIX12E45	CAX12E45
14"	45°	4-1/8"	10-1/8"	CIX14E45	CAX14E45
16"	45°	4-7/16"	10-13/16"	CIX16E45	CAX16E45
18"	45°	4-11/16"	11-1/2"	CIX18E45	CAX18E45
20"	45°	5"	12-13/16"	CIX20E45	CAX20E45
22"	45°	5-5/16"	12-15/16"	CIX22E45	CAX22E45
24"	45°	5-5/8"	13-5/8"	CIX24E45	CAX24E45
26"	45°	5-7/8"	14-5/16"	CIX26E45	CAX26E45
28"	45°	6-3/16"	15-1/16"	CIX28E45	CAX28E45
30"	45°	6-1/2"	15-3/4"	CIX30E45	CAX30E45
32"	45°	6-3/4"	16-7/16"	CIX32E45	CAX32E45
34"	45°	7-1/16"	17-3/16"	CIX34E45	CAX34E45
36"	45°	7-3/8"	17-7/8"	CIX36E45	CAX36E45



Materials available: 304, 316, Galvalume
Flow resistance: K = 0.15

Elbows

90° Elbow Offset Table

Ø	90° Offset	90° Height
5"	9-23/32"	9-27/32"
6"	10-5/32"	10-5/16"
8"	11-7/32"	11-11/32"
10"	12-7/32"	12-5/16"
12"	13-1/8"	13-5/16"
14"	14-3/16"	14-3/8"
16"	15-7/32"	15-5/16"
18"	16-1/8"	16-5/16"
20"	17-19/32"	18-11/32"
22"	18-7/32"	18-11/32"
24"	19-1/4"	19-9/32"
26"	20-5/32"	20-9/32"
28"	21-7/32"	21-11/32"
30"	22-7/32"	22-9/32"
32"	23-5/32"	23-9/32"
34"	24-7/32"	24-11/32"
36"	25-7/32"	25-5/16"

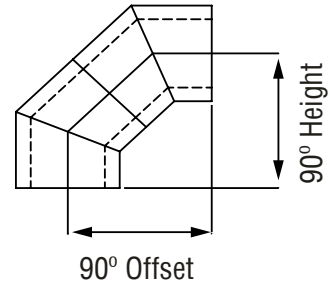

Tees

90° Tees

Use to change direction at 90° breeching or inspection access.
 Use as an inspection access in horizontal runs for grease duct applications (CIX only). Do not use in diesel/turbine applications.
 Locking band included.

Ø	Offset	Height	Snout	CIX	CAX
5"	6-1/2"	15"	6-1/2"	CIX5T90	CAX5T90
6"	7"	16"	7"	CIX6T90	CAX6T90
8"	8"	18"	8"	CIX8T90	CAX8T90
10"	9"	20"	9"	CIX10T90	CAX10T90
12"	10"	22"	10"	CIX12T90	CAX12T90
14"	11"	24"	11"	CIX14T90	CAX14T90
16"	12"	26"	12"	CIX16T90	CAX16T90
18"	13"	28"	13"	CIX18T90	CAX18T90
20"	14"	30"	14"	CIX20T90	CAX20T90
22"	15"	32"	15"	CIX22T90	CAX22T90
24"	16"	34"	16"	CIX24T90	CAX24T90
26"	17"	36"	17"	CIX26T90	CAX26T90
28"	18"	38"	18"	CIX28T90	CAX28T90
30"	19"	40"	19"	CIX30T90	CAX30T90
32"	20"	42"	20"	CIX32T90	CAX32T90
34"	21"	44"	21"	CIX34T90	CAX34T90
36"	22"	46"	22"	CIX36T90	CAX36T90

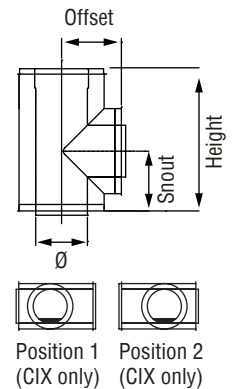

Available with smaller snout Ø. Code: CIXØT90BØ/CAXØT90BØ
 Available with a dam in position 1 or 2. Code: CIXØT90P (1 or 2)
 Materials available: 304, 316, Galvalume. Flow resistance: K = 1.25

Tees

45° Tees

Use to change direction at 45° breeching or inspection access.

Ø	Offset	Height	Snout	CIX	CAX
5"	10-7/16"	20-5/8"	4-5/16"	CIX5T45	CAX5T45
6"	11-5/16"	22-1/16"	4-11/16"	CIX6T45	CAX6T45
8"	13"	24-7/8"	5-3/8"	CIX8T45	CAX8T45
10"	14-3/4"	27-11/16"	6-1/8"	CIX10T45	CAX10T45
12"	16-7/16"	30-9/16"	6-13/16"	CIX12T45	CAX12T45
14"	18-1/8"	33-3/8"	7-1/2"	CIX14T45	CAX14T45
16"	19-7/8"	36-3/16"	8-1/4"	CIX16T45	CAX16T45
18"	21-9/16"	39"	8-15/16"	CIX18T45	CAX18T45
20"	23-1/4"	41-7/8"	9-5/8"	CIX20T45	CAX20T45
22"	24-15/16"	44-11/16"	10-5/16"	CIX22T45	CAX22T45
24"	26-11/16"	47-1/2"	11-1/16"	CIX24T45	CAX24T45
26"	28-3/8"	50-5/16"	11-3/4"	CIX26T45	CAX26T45
28"	30-1/16"	53-3/16"	12-7/16"	CIX28T45	CAX28T45
30"	31-13/16"	56"	13-3/16"	CIX30T45	CAX30T45
32"	33-1/16"	58-13/16"	13-7/8"	CIX32T45	CAX32T45
34"	35-3/16"	61-5/8"	14-9/16"	CIX34T45	CAX34T45
36"	36-15/16"	64-1/2"	15-5/16"	CIX36T45	CAX36T45

Available with smaller snout Ø. Locking Band included. Code: CIXØT45BØ/
CAXØT45BØ Materials available: 304, 316, Galvalume. Flow resistance: K = 0.4

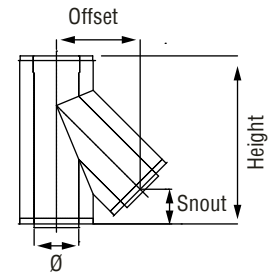

Double 45° Tee, Smaller Snout

Used to change direction at 45° breeching or inspection access.

Ø	Offset	Height	Snout	CIX	CAX
5"	10-7/16"	20-5/8"	4-5/16"	CIX5T45	CAX5T45
6"	11-5/16"	22-1/16"	4-11/16"	CIX6T45	CAX6T45
8"	13"	24-7/8"	5-3/8"	CIX8T45	CAX8T45
10"	14-3/4"	27-11/16"	6-1/8"	CIX10T45	CAX10T45
12"	16-7/16"	30-9/16"	6-13/16"	CIX12T45	CAX12T45
14"	18-1/8"	33-3/8"	7-1/2"	CIX14T45	CAX14T45
16"	19-7/8"	36-3/16"	8-1/4"	CIX16T45	CAX16T45
18"	21-9/16"	39"	8-15/16"	CIX18T45	CAX18T45
20"	23-1/4"	41-7/8"	9-5/8"	CIX20T45	CAX20T45
22"	24-15/16"	44-11/16"	10-5/16"	CIX22T45	CAX22T45
24"	26-11/16"	47-1/2"	11-1/16"	CIX24T45	CAX24T45
26"	28-3/8"	50-5/16"	11-3/4"	CIX26T45	CAX26T45
28"	30-1/16"	53-3/16"	12-7/16"	CIX28T45	CAX28T45
30"	31-13/16"	56"	13-3/16"	CIX30T45	CAX30T45
32"	33-1/2"	58-13/16"	13-7/8"	CIX32T45	CAX32T45
34"	35-3/16"	61-5/8"	14-9/16"	CIX34T45	CAX34T45
36"	36-15/16"	64-1/2"	15-5/16"	CIX36T45	CAX36T45

Available with smaller snout. Code: CIXØTD45BØ/CAXØTD45BØ
Materials available: 304, 316, Galvalume. Flow resistance: K = 0.4

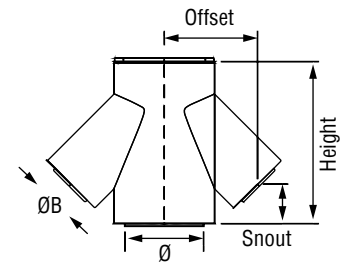

Tees

45° Tee Relief Valve

Use to combine with the relief valve and female ANSI flange adapter. Locking band included. Same dimensions as 45° Tee. Locking band included.

Ø	CIX	CAX
5" to 36"	CIXØT45RV	CAXØT45RV

Materials available: 304, 316, Galvalume
Flow resistance: $K = 0.4$

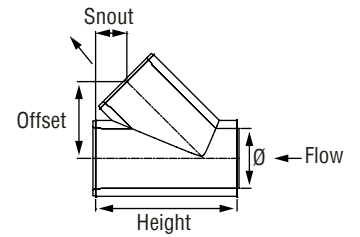

45° Tee Y

Use to provide low-pressure drop for joining appliances. Offers same diameter on all branches. Available with smaller snout. Locking band included.

Ø	Offset	Height	CIX	CAX
5"	4-9/16"	10-7/16"	CIX5TY	CAX5TY
6"	4-15/16"	11"	CIX6TY	CAX6TY
8"	5-5/8"	12-1/8"	CIX8TY	CAX8TY
10"	6-5/16"	13-1/4"	CIX10TY	CAX10TY
12"	7-1/16"	14-3/8"	CIX12TY	CAX12TY
14"	7-3/4"	15-1/2"	CIX14TY	CAX14TY
16"	8-7/16"	16-9/16"	CIX16TY	CAX16TY
18"	9-3/16"	17-11/16"	CIX18TY	CAX18TY
20"	9-7/8"	18-13/16"	CIX20TY	CAX20TY
22"	10-9/16"	19-15/16"	CIX22TY	CAX22TY
24"	11-5/16"	21-1/16"	CIX24TY	CAX24TY
26"	12"	22-3/16"	CIX26TY	CAX26TY
28"	12-11/16"	23-5/16"	CIX28TY	CAX28TY
30"	13-7/16"	24-7/16"	CIX30TY	CAX30TY
32"	14-1/8"	25-9/16"	CIX32TY	CAX32TY
34"	14-13/16"	26-11/16"	CIX34TY	CAX34TY
36"	15-9/16"	27-13/16"	CIX36TY	CAX36TY

Available with smaller snout Ø. Code: CIXØTYØ/CAXØTYØ
Materials available: 304, 316, Galvalume Flow resistance: $K = 0.6$

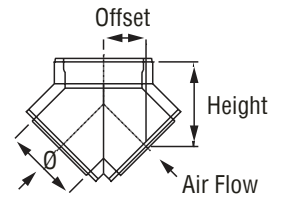

Tees

90° Grease Tees (CIX only)

Use in grease duct applications as a horizontal-to-vertical connection with an inspection or clean-out access. Locking band included. Dam can be ordered in #1, 2 or 3 position.

Ø	Offset	Height	CIX	CAX
5"	8-1/2"	6-1/2"	CIX5GTY	CAX5TY
6"	9"	7"	CIX6GTY	CAX6TY
8"	10"	8"	CIX8GTY	CAX8TY
10"	11"	9"	CIX10GTY	CAX10TY
12"	12"	10"	CIX12GTY	CAX12TY
14"	13"	11"	CIX14GTY	CAX14TY
16"	14"	12"	CIX16GTY	CAX16TY
18"	15"	13"	CIX18GTY	CAX18TY
20"	16"	14"	CIX20GTY	CAX20TY
22"	17"	15"	CIX22GTY	CAX22TY
24"	18"	16"	CIX24GTY	CAX24TY
26"	19"	17"	CIX26GTY	CAX26TY
28"	20"	18"	CIX28GTY	CAX28TY
30"	21"	19"	CIX30GTY	CAX30TY
32"	22"	20"	CIX32GTY	CAX32TY
34"	23"	21"	CIX34GTY	CAX34TY
36"	24"	22"	CIX36GTY	CAX36TY

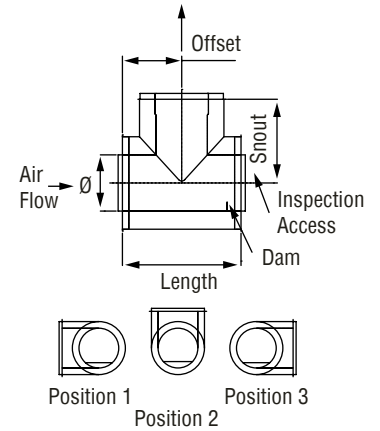

Available with smaller snout Ø. Code: CIXØTYØ/CAXØTYØ
 Materials available: 304, 316, Galvalume. Flow resistance: K = 1.25

Dimensional Information for Assembled T45 and 45° Elbow

Ø	Offset	Height
5"	17-3/8"	19-1/8"
6"	18-9/16"	20-5/16"
8"	21"	22-3/4"
10"	23-7/16"	25-1/8"
12"	25-13/16"	27-9/16"
14"	28-1/4"	30"
16"	30-11/16"	32-3/8"
18"	33-1/16"	34-3/4"
20"	35-7/16"	37-1/4"
22"	37-7/8"	39-11/16"
24"	40-5/16"	42-1/16"
26"	42-11/16"	44-7/16"
28"	45-1/8"	46-15/16"
30"	47-9/16"	49-5/16"
32"	49-15/16"	51-11/16"
34"	52-3/8"	54-1/8"
36"	54-13/16"	56-9/16"

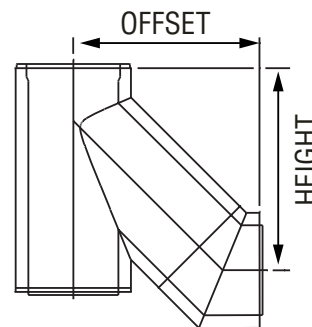

Tees

Grease Tees (CIX only)

Use to provide low-pressure drop for joining appliances. Offers same diameter on all branches. Available with smaller snout. Locking band included. Locking band included.

Ø	Offset	Snout	CIX
5"	8-1/2"	6-1/2"	CIX5GTY
6"	9"	7"	CIX6GTY
8"	10"	8"	CIX8GTY
10"	11"	9"	CIX10GTY
12"	12"	10"	CIX12GTY
14"	13"	11"	CIX14GTY
16"	14"	12"	CIX16GTY
18"	15"	13"	CIX18GTY
20"	16"	14"	CIX20GTY
22"	17"	15"	CIX22GTY
24"	18"	16"	CIX24GTY
26"	19"	17"	CIX26GTY
28"	20"	18"	CIX28GTY
30"	21"	19"	CIX30GTY
32"	22"	20"	CIX32GTY
34"	23"	21"	CIX34GTY
36"	24"	22"	CIX36GTY

Available with smaller snout Ø Code: CIXØTYØ/CAXØTYØ
 Materials available: 304, 316, Galvalume.
 Flow resistance: K = 1.25

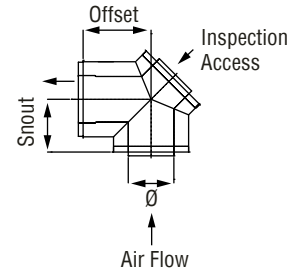

Tee Cap

Use to close and seal unused tee ports. Locking band included.

Ø (in.)	CIX	CAX
5" to 36"	CIXØTC	CAXØTC

Material available: 304, 316, Galvalume.

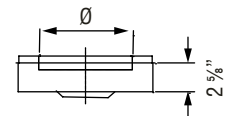

Drain Tee Cap

Use to close and seal unused tee ports and to provide drain point for rain or condensation. Locking band included.

Ø	CIX	CAX
5" to 36"	CIXØDTC	CAXØDTC

Materials available: 304, 316, Galvalume.

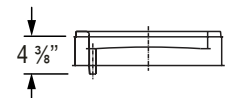

Accessories

No Tool Access Door

Use for inspection and cleaning. Greaseproof and fire-tight seal. Replacement gaskets available.

Ø	Effective Length	CIX
5" to 36"	23-3/8"	CIXØADL24
5" to 36"	35-3/8"	CIXØADL36

Materials available: 304, 316, Galvalume.

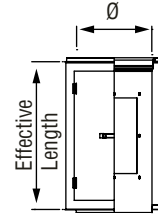

Locking Band

Use to clamp and seal parts together. To be sealed with outer joint sealant (not included). Included with components that require the locking band.

Ø	CIX
5" to 36"	CIXØBSC

Materials available: 304.

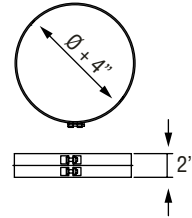

Damper Length

Ø	Effective Length	CIX	CAX
5" to 36"	11-3/8"	CIX5L12DAMP	CAX5L12DAMP
		CIX6L12DAMP	CAX6L12DAMP
		CIX8L12DAMP	CAX8L12DAMP
		CIX10L12DAMP	CAX10L12DAMP
		CIX12L12DAMP	CAX12L12DAMP
14" to 18"	17-3/8"	CIX14L18DAMP	CAX14L18DAMP
		CIX16L18DAMP	CAX16L18DAMP
		CIX18L18DAMP	CAX18L18DAMP
		CIX20L24DAMP	CAX20L24DAMP
20" to 24"	23-3/8"	CIX22L24DAMP	CAX22L24DAMP
		CIX24L24DAMP	CAX24L24DAMP

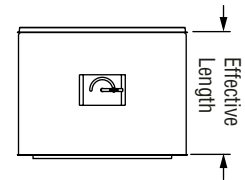

Manual Draft Damper available in all material options.

Tapered Increaser

Use when a pipe diameter change is required. Locking band included.

Ø	A	B	CIX	CAX
One Ø Increase	8"	2"	CIXØTINS1	CAXØTINS1
Two Ø Increase	12"	4"	CIXØTINS2	CAXØTINS2
Three Ø Increase	16"	6"	CIXØTINS3	CAXØTINS3

Materials available: 304, 316, Galvalume.

Flow resistance: $K = 0.51 [1 - (\frac{\delta}{\delta+B})^2]^2 / (\frac{\delta}{\delta+B})^4$

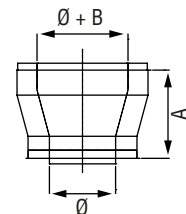

Accessories

Stepped Increaser

Use when a pipe diameter change is required in a small space. More restrictive than the tapered increaser. Locking band included.

Ø	ØB	CIX	CAX
5" to 32"	8" to 36"	CIXØIN(ØB)	CAXØIN(ØB)

Materials available: 304, 316, Galvalume.
Flow resistance: $K = [1 - (\frac{\delta}{\delta+B})^2]^2 / (\frac{\delta}{\delta+B})^4$

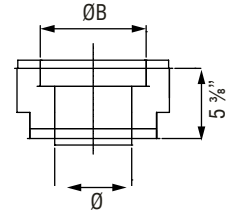

ANSI Flange Adapter

Use for connecting a 125 or 150 lb. ANSI flange. 1/4" thickness with a bolt hole pattern, bolt hole center pattern and quantity per 125-lb ANSI. Locking band included.

Ø	Ø A	Male		Female	
		CIX	CAX	CIX	CAX
5"	10"	CIX5FA	CAX5FA	CIX5FFA	CAX5FFA
6"	11"	CIX6FA	CAX6FA	CIX6FFA	CAX6FFA
8"	13-1/2"	CIX8FA	CAX8FA	CIX8FFA	CAX8FFA
10"	16"	CIX10FA	CAX10FA	CIX10FFA	CAX10FFA
12"	19"	CIX12FA	CAX12FA	CIX12FFA	CAX12FFA
14"	21"	CIX14FA	CAX14FA	CIX14FFA	CAX14FFA
16"	23"	CIX16FA	CAX16FA	CIX16FFA	CAX16FFA
18"	25"	CIX18FA	CAX18FA	CIX18FFA	CAX18FFA
20"	27-1/2"	CIX20FA	CAX20FA	CIX20FFA	CAX20FFA
22"	29 1/2"	CIX22FA	CAX22FA	CIX22FFA	CAX22FFA
24"	32"	CIX24FA	CAX24FA	CIX24FFA	CAX24FFA
26"	34-1/2"	CIX26FA	CAX26FA	CIX26FFA	CAX26FFA
28"	36-1/2"	CIX28FA	CAX28FA	CIX28FFA	CAX28FFA
30"	38-1/2"	CIX30FA	CAX30FA	CIX30FFA	CAX30FFA
32"	42"	CIX32FA	CAX32FA	CIX32FFA	CAX32FFA
34"	44"	CIX34FA	CAX34FA	CIX34FFA	CAX34FFA
36"	46"	CIX36FA	CAX36FA	CIX36FFA	CAX36FFA

Materials available: 304, 316, Galvalume.

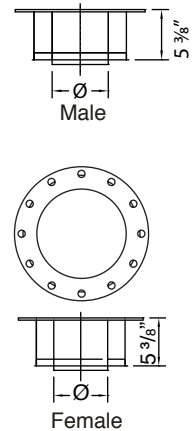
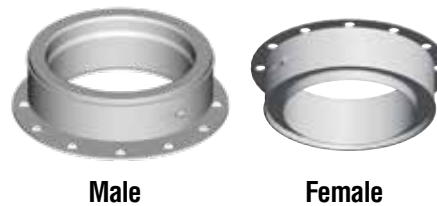

Single Wall Adaptor

Use as a non-welded attachment for appliances having an unflanged outlet. Locking band included.

Ø	Male (For CIX & CAX)	Female (For CIX & CAX)
5" to 36"	CIXØSWA	CIXØFSWA

Materials available: 304, 316.
Flow resistance: $K = 0.4$ (eff. length [ft] / Ø [in]); $K = 0.25$ (eff. length [ft] / Ø [in])

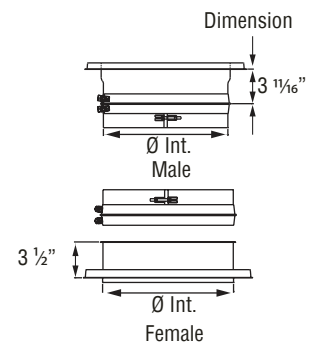

Accessories

Flanged Adaptor

Use on standard appliances such as kitchen hood exhausts. Flanged at the end. Locking band included.

Ø	(For CIX & CAX)	Female (For CIX & CAX)
5" to 36"	CIXØFHA	CIXØFFHA

Materials available: 304, 316.

Flow resistance: $K = 0.4$ (eff. length [ft] / Ø [in])

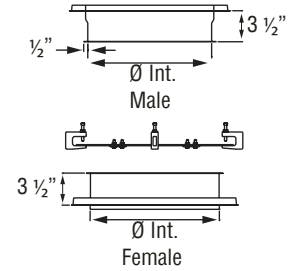
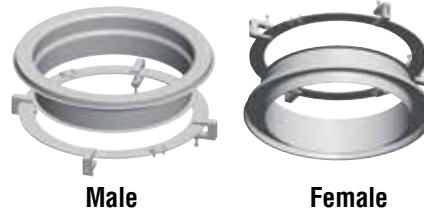

Cleaverbrooks Flex Adaptor

Use as starter piece for Flexible Watertube FLX Cleaver Brooks appliance.

Ø	A	B	CIX
10" to 24"	Custom	Custom	CIXCBFLX

Materials available: 304.

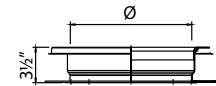

Viessmann Vitorond Adaptor

Use as single wall starter piece for Vitorond VD2 and VD2A Viessmann appliances.

Ø	A	B	C	CIX
8"	6.969"	7-15/32"	5 13/32"	CIX8VSSVD2
12"	11.161"	7-11/16"	5 9/32"	CIX12VSSVD2

Materials available: 304, 316.

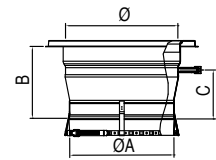

Fan Adaptor

Use for connection to an "up-blast" kitchen fan.

Ø	A	B	CIX
5" to 36"	Custom	Custom	CIXØFAN(AB)

Materials available: 304, 316, Galvalume.

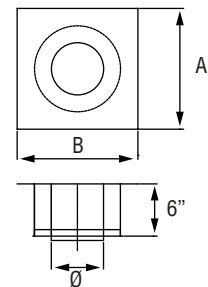

Square to Round Adaptor

Connects to kitchen hood. Locking band included. Made to order.

Ø	A	B	CIX	CAX
5" to 36"	Custom	Custom	CIXØSTR(AB)	CAXØSTR(AB)

Materials available: 304, 316, Galvalume.
Not listed.

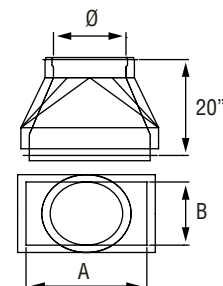

Accessories

CT to CIX/CAX Adaptor

Use to connect CT model chimney liner to CIX or CAX. Locking band included.

Ø	CIX & CAX
5" to 36"	CIXØRCTMB

Materials available: 316. Flow resistance: $K = 0.4$ (eff. length [ft] / Ø [in]); $K = 0.25$ (eff. length [ft] / Ø [in]); For engine or turbine exhaust

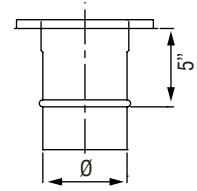

CIX/CAX to CT Adaptor

Use to connect CIX or CAX model chimney to CT chimney liner. Locking band included.

Ø	CIX & CAX
5" to 36"	CIXØRCTFB

Materials available: 316. Flow resistance: $K = 0.4$ (eff. length [ft] / Ø [in]); $K = 0.25$ (eff. length [ft] / Ø [in]); For engine or turbine exhaust.

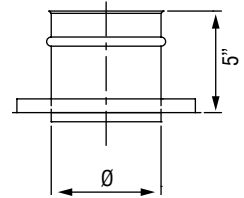

Anchor Plate

Use for supporting the stack in vertical or horizontal runs and to provide a fixed point for thermal expansion consideration. Maintains a minimum of 1" clearance to the opening on CIX installations and 4" clearance to the opening on CAX. All hardware included except connection to structure. Must not be in contact with combustible.

Ø	CIX	CAX
5" to 36"	CIXØAPF	CAXØAPF

Materials available: Galvanized.

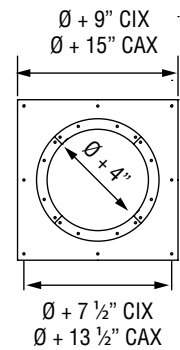

Anchor Plate - Heavy Duty

Use for supporting the stack in vertical or horizontal runs and to provide a fixed point for thermal expansion consideration. Heavy-duty steel "C" channel base - 2 1/2" x 1 1/2".

Ø	CIX	CAX
5" to 36"	CIXØAPHDF	CAXØAPHDF

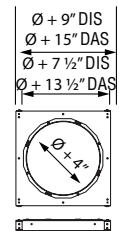
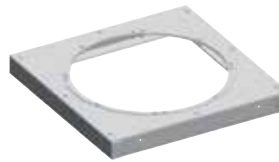

Anchor Plate - Ventilated

Use for supporting the stack in vertical runs in contact with combustible materials and to provide a fixed point for thermal expansion consideration. Maintains a minimum of 2" clearance to the opening on CIX and 4 1/2" on CAX. All hardware included except connection to structure.

Ø	CIX	CAX
5" to 36"	CIXØAPVF	CAXØAPVF

Materials available: Galvanized.

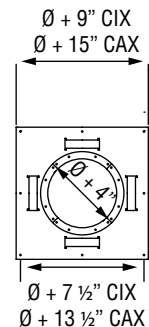

Accessories

Length Anchor Plate

Composed of a straight section with an effective length of 3¾" for CIX, integrated into a support plate. The Length Anchor Plate doesn't need any clamp flange (and its hardware) for its installation, so it is easier and faster to install. The APL must be attached to the building structure or support with rigid non-combustible structural members.

Ø	CIX	CAX
5" to 36"	CIXØAPL	CAXØAPL

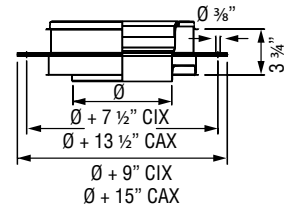
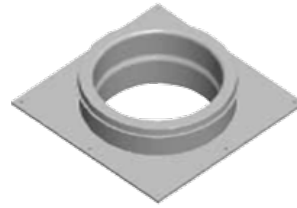

Wall Support

Use for supporting the stack in vertical runs in contact with combustible materials and to provide a fixed point for thermal expansion consideration. Maintains a minimum of 2½" clearance to the wall on CIX and 4½" on CAX, and up to 7½" on CIX and 9½" on CAX when wall brace is extended. All hardware included except connection at wall.

Ø	A	CIX	CAX
5" to 36"	0" to 5"	CIXØWSF	CAXØWSF

Materials available: Galvanized.

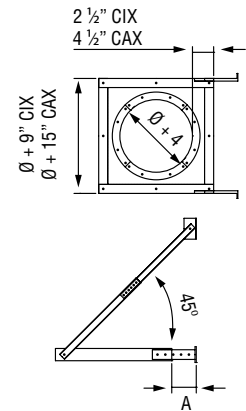

Cradle Support

Use for supporting and guiding the stack in horizontal runs. Not recommended for thermal expansion systems. See installation instructions for spacing.

Ø	CIX & CAX
5" to 36"	CIXØCSE

Materials available: Galvanized.

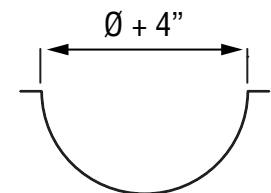

Half Angle Ring

Use for supporting and guiding the stack in horizontal runs. Not recommended for thermal expansion systems. See installation instructions for spacing.

Ø	CIX & CAX
5" to 36"	CIXØHARP

Materials available: SS 439.

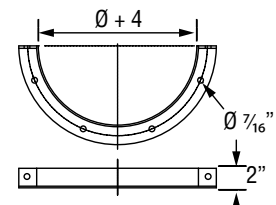

Suspension Band

Use for supporting and guiding the stack in horizontal runs. Allows 4" of travel for thermal expansion. Rail, trolley and band included. Flexible support strap (not included) is used to join the band and the trolley-see instruction manual for required specifications. All hardware included except connection to structure.

Ø	CIX & CAX
5" to 36"	CIXØSBE

Materials available: Galvalume.

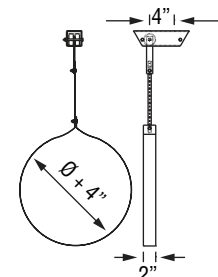

Accessories

Wall Guide

Use for guiding vertical installation attached to the wall. Maintains a minimum of 1" clearance to the wall on CIX and 4" on CAX. Extension for additional clearance of 3½" is included. All hardware included except connection to structure. Flexible strap (not included) can be used to add rigidity when using extension—see instruction manual for required specifications

Ø	A	B	CIX	CAX
5"	7-7/8"	6-1/8"	CIX5WGE	CAX5WGE
6"	8-9/16"	6-13/16"	CIX6WGE	CAX6WGE
8"	10"	8-1/4"	CIX8WGE	CAX8WGE
10"	11-13/32"	9-21/32"	CIX10WGE	CAX10WGE
12"	12-13/16"	11-1/16"	CIX12WGE	CAX12WGE
14"	14-7/32"	12-15/32"	CIX14WGE	CAX14WGE
16"	15-21/32"	13-29/32"	CIX16WGE	CAX16WGE
18"	17-1/16"	15-5/16"	CIX18WGE	CAX18WGE
20"	18-15/32"	16-23/32"	CIX20WGE	CAX20WGE
22"	19-7/8"	18-1/8"	CIX22WGE	CAX22WGE
24"	21-5/16"	19-9/16"	CIX24WGE	CAX24WGE
26"	22-23/32"	20-31/32"	CIX26WGE	CAX26WGE
28"	24-1/8"	22-3/8"	CIX28WGE	CAX28WGE
30"	25-17/32"	23-25/32"	CIX30WGE	CAX30WGE
32"	26-31/32"	25-7/32"	CIX32WGE	CAX32WGE
34"	28-3/8"	26-5/8"	CIX34WGE	CAX34WGE
36"	29-25/32"	28-1/32"	CIX36WGE	CAX36WGE

Materials available: Galvalume.

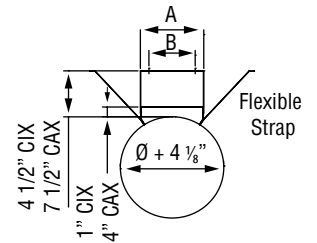

Floor Guide

Use for guiding in vertical installation when passing through a floor or roof. Maintains a minimum of 2" clearance to the opening on CIX installations and 4" clearance to the opening on CAX. All hardware included except connection to structure.

Ø	CIX	CAX
5" to 36"	CIXØFGF	CAXØFGF

Materials available: Galvanized.

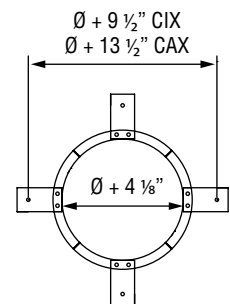

Guy Wire

Use for guiding in vertical installation above the roof. All hardware included except wire, tensioner and connection to roof. See instruction manual for required specifications.

Ø	CIX & CAX
5" to 36"	CIXØGWE

Materials available: Galvalume.

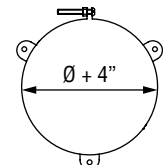

Accessories

Roof/Floor Penetration Shield

Use where chimney passes through a combustible roof or structure. Maintains a minimum of 2" clearance to the opening on CIX installations and 4" clearance to the opening on CAX.

Ø	CIX	CAX
5" to 36"	CIXØFSE	CAXØFSE

Materials available: Galvalume.

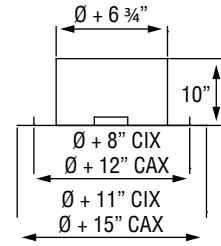
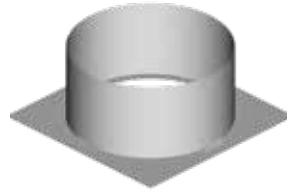

Wall Thimble

Use where chimney passes through a combustible wall. Maintains a minimum of 2" clearance to the opening on CIX installations and 4" clearance to the opening on CAX. Not listed for diameter larger than 10".

Ø	A	CIX	CAX
5" to 36"	7" to 12"	CIXØFSWE	CAXØFSWE

Materials available: Galvalume.

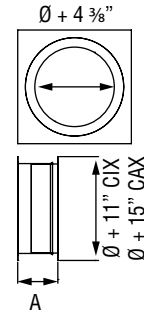
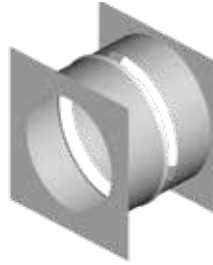

No Loss Cap

Ø	A	CIX & CAX
5"	19-11/16	CIX5CNL
6"	23-11/16	CIX6CNL
8"	31-11/16	CIX8CNL
10"	36-7/16	CIX10CNL
12"	48-9/16	CIX12CNL
14"	55-9/16	CIX14CNL
16"	64-3/16	CIX16CNL
18"	72-3/16	CIX18CNL
20"	72-3/16	CIX20CNL
22"	72-3/16	CIX22CNL
24"	72-3/16	CIX24CNL

Materials available: 304.

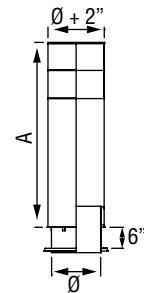

Roof Brace

Use for bracing in vertical installation above the roof. All hardware included except brace and connection to roof.

Ø	CIX & CAX
5" to 36"	CIXØRBE

Materials available: Galvalume.

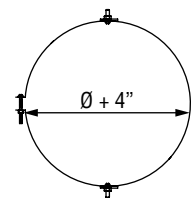

Accessories

Flashing

Use in conjunction with storm collar for weatherization at the roof. Storm collar included.

Ø	CIX	CAX
5" to 36"	CIXØF	CAXØF

Materials available: Galvalume, Stainless.

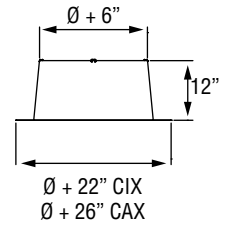

Adjustable Flashing

Use in conjunction with storm collar for weatherization at the roof. 5° to 30° pitch.

Ø	A	B	CIX	CAX
5	35 3/8"	12 7/16"	CIX5F30	CAX5F30
6	36 1/2"	12 7/16"	CIX6F30	CAX6F30
8	36 1/2"	12 7/16"	CIX8F30	CAX8F30
10	41"	12 7/16"	CIX10F30	CAX10F30
12	43"	12 7/16"	CIX12F30	CAX12F30
14	45"	12 7/16"	CIX14F30	CAX14F30
16	47 1/4"	12 7/16"	CIX16F30	CAX16F30
18	49 1/2"	12 7/16"	CIX18F30	CAX18F30
20	51 1/2"	12 7/16"	CIX20F30	CAX20F30
22	53 1/2"	12 7/16"	CIX22F30	CAX22F30
24	56"	12 7/16"	CIX24F30	CAX24F30
26	58"	12 7/16"	CIX26F30	CAX26F30
28	60"	12 15/16"	CIX28F30	CAX28F30
30	63"	13 15/32"	CIX30F30	CAX30F30
32	65"	13 15/32"	CIX32F30	CAX32F30
34	67 1/2"	13 31/32"	CIX34F30	CAX34F30
36	70"	13 31/32"	CIX36F30	CAX36F30

Materials available: Galvalume, Stainless.

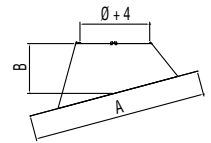
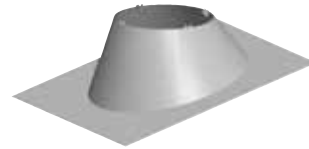

Storm Collar

Use above the flashing for complete weatherization above the roof. To be sealed with outer joint sealant (not included).

Ø	CIX & CAX
5" to 36"	CIXØSC

Materials available: Galvalume, Stainless.

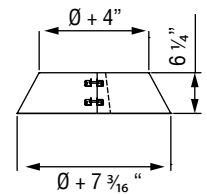

Accessories

Rain Cap

Use to provide the greatest degree of rain protection. Model 2 is available with bird screen.

Ø	Model	CIX & CAX	w/Bird Screen
5" to 10"	1	CIXØRCC	--
12" to 18"	2	CIXØRCC	CIXØRCBC

Materials available: 304.

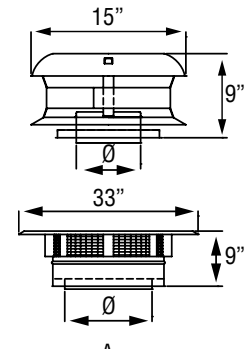
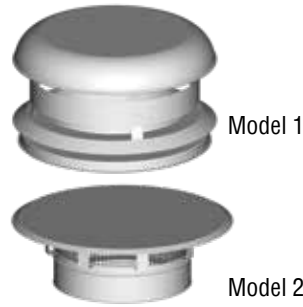

Cone Rain Cap

Use to provide the greatest degree of rain protection. Available with bird screen.

Ø	A	B	CIX/CAX	w/Bird Screen
5"	19-7/8"	12-1/2"	CIX5CRCC	CIX5CRCBC
6"	19-7/8"	13"	CIX6CRCC	CIX6CRCBC
8"	24"	15-1/4"	CIX8CRCC	CIX8CRCBC
10"	27-3/4"	17-1/8"	CIX10CRCC	CIX10CRCBC
12"	27-3/4"	17-7/8"	CIX12CRCC	CIX12CRCBC
14"	31-1/2"	17-7/8"	CIX14CRCC	CIX14CRCBC
16"	31-1/2"	18-5/8"	CIX16CRCC	CIX16CRCBC
18"	44"	25-3/4"	CIX18CRCC	CIX18CRCBC
20"	44"	26-1/8"	CIX20CRCC	CIX20CRCBC
22"	44"	26-3/4"	CIX22CRCC	CIX22CRCBC
24"	56"	31-1/2"	CIX24CRCC	CIX24CRCBC
26"	56"	32-1/8"	CIX26CRCC	CIX26CRCBC
28"	56"	31-7/8"	CIX28CRCC	CIX28CRCBC
30"	56"	32-1/2"	CIX30CRCC	CIX30CRCBC
32"	60"	33-1/8"	CIX32CRCC	CIX32CRCBC
34"	60"	33-1/8"	CIX34CRCC	CIX34CRCBC
36"	60"	33-3/4"	CIX36CRCC	CIX36CRCBC

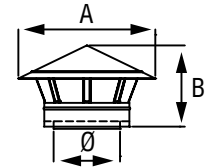

Finishing Cone

Use to provide the greatest draft. Requires a drain at bottom of stack.

Ø	A	CIX & CAX
5" to 36"	10" to 27"	CIXØFC

Materials available: 304, 316, Galvalume.

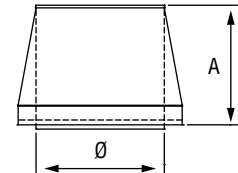

Accessories

Flip Top

Use to prevent moisture and debris from entering system. Flip top opens with internal pressure and closes when no pressure is present. For engine exhaust application.

Ø	CIX & CAX
5" to 24"	CIXØFTC

Materials available: 304.

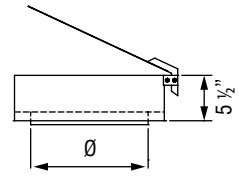

Miter Cut

Use for horizontal engine exhaust termination.

Ø	CIX & CAX
5" to 36"	CIXØMCC

Materials available: 304.

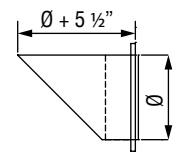

Relief Valve

Helps control the venting pressure should a backfire occur. Must be used in conjunction with ANSI flanged adapter and 45° tee relief valve. Use on engine exhaust.

Ø	CIX & CAX
5" to 24"	CIXØRVC

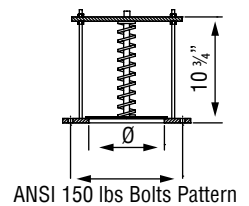
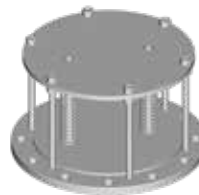

SEALANT

Location	Max Temp °F	Color	Product Code (For CIX & CAX)
Inner Joint	650	Red	S-650
Outer Joint	375	Gray	S-375
Inner Wall	2000	White	S-2000

Red sealant is used in combination with the locking band.

Gray sealant is used to protect from rain entering the system when chimney runs outside of building and is subject to rain.

White sealant is used in combination with the seal band and also for grease duct applications.

SEALANT COVERAGE

Ø	Number of Joints
5	13
6	11
8	9
10	8
12	7
14	6
16-18	5
20-26	4
28-36	3

www.securitychimneys.com

Security Chimneys

2125 Monterey, Laval, Quebec
Canada, H7L 3T6

450-973-9999

800-361-4909 (US)

800-667-3387 (Canada)

450-973-2222 (Fax)

Need product information or technical support? Our customer service specialists are ready to answer your questions:

800-667-3387 or contact
infoeng@securitychimneys.com

(2/2017) ACIX



www.securitychimneys.com 800-361-4909 (US) 800-667-3387 (Canada)

Security Chimneys © 2015, 2017

Information published in all Security Chimneys literature is current at time of publication and is subject to change without notice.